

FEATURES

- -55°C to $+85^{\circ}\text{C}$ operation
- 0 to 40 VDC volt input
- Up to 40 dB attenuation
110 kHz to 50 MHz
- Transient suppression
- Compliant to
MIL-STD-461C, CE03

EMI INPUT FILTERS 28 VOLT INPUT

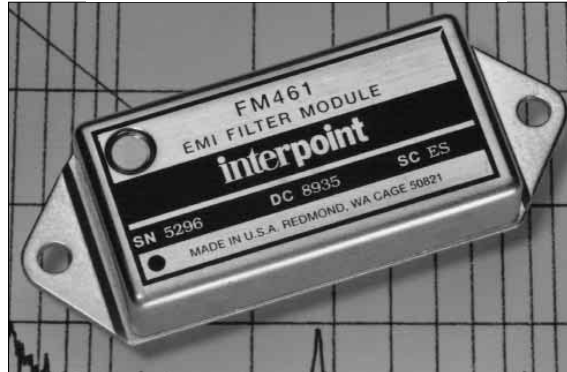

FM-461, FMA-461 AND FMB-461 EMI FILTERS 1.75 TO 5 AMP

MODELS INPUT VOLTAGE AND CURRENT

Input (V)	Current (A)
0 - 40	1.75
0 - 40	3.8
0 - 40	5.0

Size (max.): Non-flanged case H3 or H5

2.125 x 1.125 x 0.495* inches (53.98 x 28.58 x 12.57* mm)

Flanged case K4 or K6

2.910 x 1.125 x 0.495* inches (73.91 x 28.58 x 12.57* mm)

See Section B8, cases H3, H5, K4, and K6, for dimensions.

*Height varies depending on model.

Weight: Maximum – FM-461 38 grams, FMA-461 42 grams, FMB-461 43 grams

Screening: Standard or ES. See Section C2 for screening options, see Section A5 for ordering information.

DESCRIPTION

The FM-461, FMA-461, and FMB-461 EMI filter modules have been specifically designed to reduce the input line reflected ripple current of Interpoint's MTO, MTW, MHE, MLP, and MFW Series of DC/DC converters. They are intended for use in applications of high frequency (100 kHz) switch-mode DC/DC converters which must meet MIL-STD-461C levels of conducted power line noise.

These filters are built using thick-film hybrid technology and are sealed in metal packages for military, aerospace, and other high-reliability applications. See Section B8, cases H3, H5, K4, and K6 for dimensions. See Section C2 for screening options.

MIL-STD NOISE MANAGEMENT

When used in conjunction with Interpoint's DC/DC converters (see connection diagram, Figure 2), the input ripple current will be reduced by 40 dB within the frequency band of 100 kHz to 50 MHz. This gives the filter/converter combination a performance which exceeds the CE03 test limit of MIL-STD-461C. The CE03 performance of a model MHE2805S converter with and without the FM-461 filter is shown in Figures 6 and 7.

FILTER OPERATION

A fast-reacting (1 picosecond) transient suppressor clamps the input voltage at approximately 47 V, protecting the DC/DC converter from line induced transients.

The filters are rated to operate, with no degradation of performance, over the temperature range of -55°C to $+85^{\circ}\text{C}$ (as measured at the baseplate). Above 85°C , input voltage and current must be derated as specified in "Derating" on the following page. The maximum power dissipation of the filters at maximum input current represents a power loss of less than 3% at typical input voltage.

LAYOUT REQUIREMENTS

The case of the filter must be connected to the case of the converter through a low impedance connection to minimize EMI.

CRANE

interpoint

A CRANE CO. COMPANY

FM-461 EMI FILTER 1.75 TO 5 AMP

EMI INPUT FILTERS

ABSOLUTE MAXIMUM RATINGS

Input Voltage

- 0 to 40 VDC continuous

Lead Soldering Temperature (10 sec per lead)

- 300°C

Storage Temperature Range (Case)

- -55°C to +135°C

Isolation

- 100 megohm minimum at 500 V
- Any pin to case (except case pin)

DERATING

Input Voltage

Derate linearly from 100% at 85°C case to the 33 VDC at 125°C case

Input Ripple Current

Derate linearly from 100% at 85°C case to the following at 125°C case

270 mA rms FM-461
400 mA rms FMA-461
480 mA rms FMB-461

DC Input and Output Current

Derate linearly from 100% at 85°C case to the following at 125°C case

750 mA FM-461
1.7 A FMA-461
1.7 A FMB-461

RECOMMENDED OPERATING CONDITIONS

Input Voltage Range

- 0 to 40 VDC continuous

Case Operating Temperature (Tc)

- -55°C to +85°C full power
- -55°C to +125°C absolute

Electrical Characteristics: 25°C Tc, nominal Vin, unless otherwise specified.

PARAMETER	CONDITION	FM-461			FMA-461			FMB-461			UNITS
		MIN	TYP	MAX	MIN	TYP	MAX	MIN	TYP	MAX	
INPUT VOLTAGE	CONTINUOUS	0	28	40	0	28	40	0	28	40	VDC
INPUT CLAMPING VOLTAGE	-55°C	38.9	43.2	47.5	38.9	43.2	47.5	38.9	43.2	47.5	VDC
	+25°C	42.3	47.0	51.7	42.3	47.0	51.7	42.3	47.0	51.7	
	+125°C	44.9	49.9	54.8	44.9	49.9	54.8	44.9	49.9	54.8	
INPUT CURRENT	DC	—	—	1.75	—	—	3.8	—	—	5.0	A
	RIPPLE	—	—	0.67	—	—	1.0	—	—	1.2	A rms
NOISE REJECTION	15 kHz - 50 MHz	—	40	—	—	40	—	—	40	—	dB
DC RESISTANCE (R _{DC})	STEADY STATE	—	0.38	0.42	0.07	0.10	0.15	0.07	0.09	0.10	Ω
CAPACITANCE	ANY PIN TO CASE	1900	—	2200	3700	—	4400	6450	—	8000	pF
OUTPUT VOLTAGE ¹	STEADY STATE	$V_{OUT} = V_{IN} - I_{IN}(R_{DC})$									VDC
OUTPUT CURRENT	STEADY STATE	—	—	1.75	—	—	3.8	—	—	5.0	A
POWER DISSIPATION	MAX. CURRENT	—	—	1.3	—	—	1.6	—	—	2.5	W

Note
1. Typical applications result in Vout within 2% of Vin.

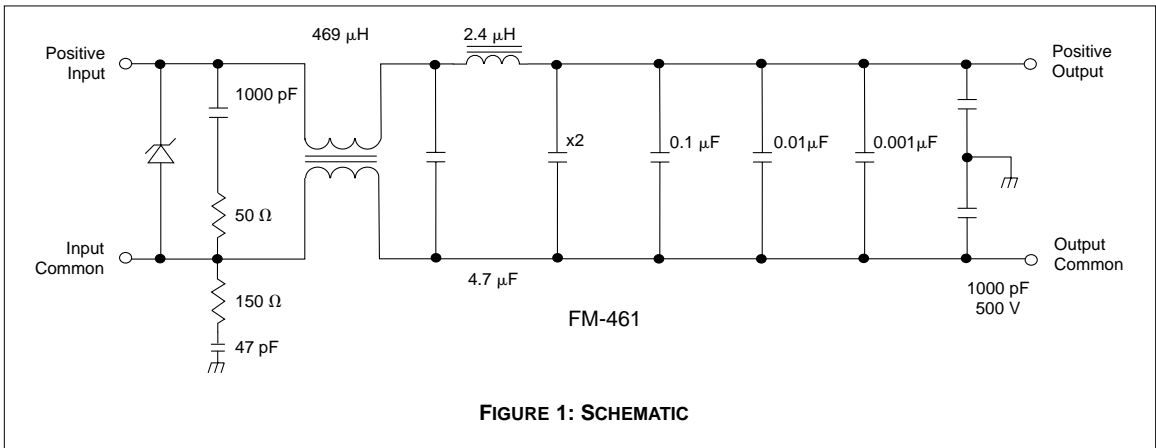
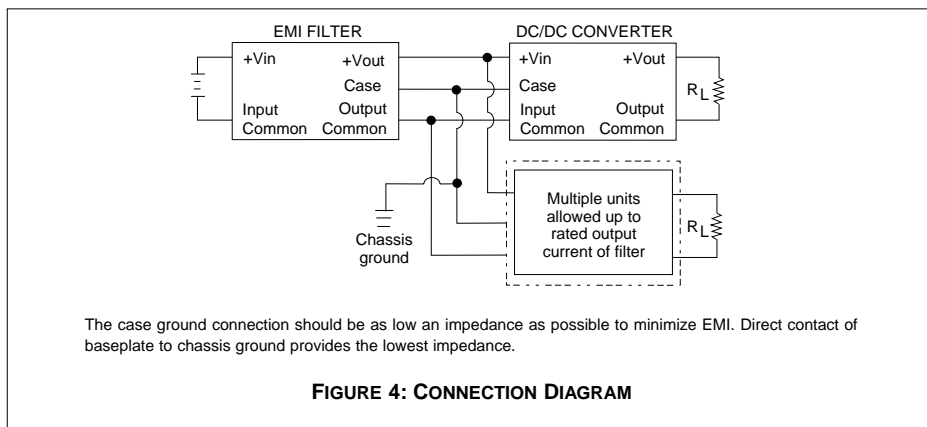
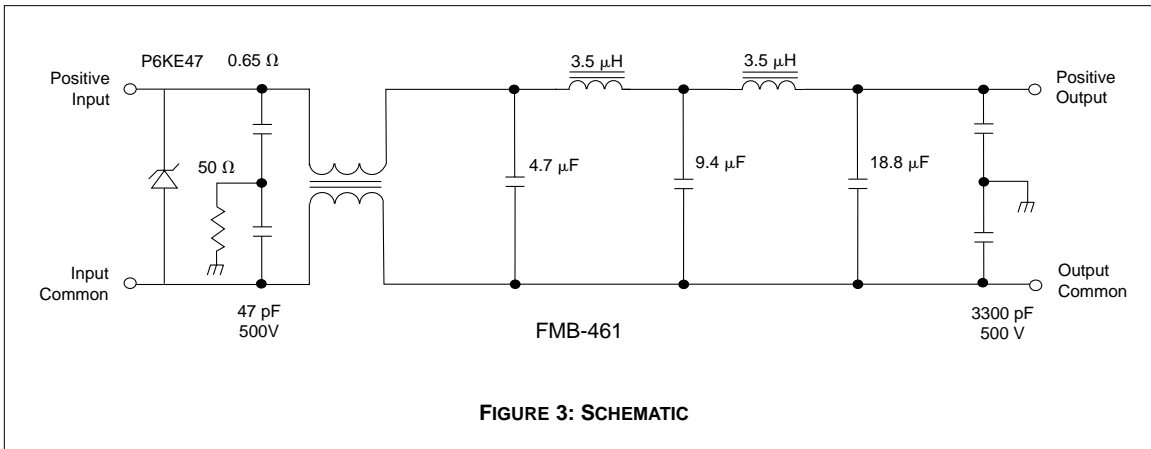
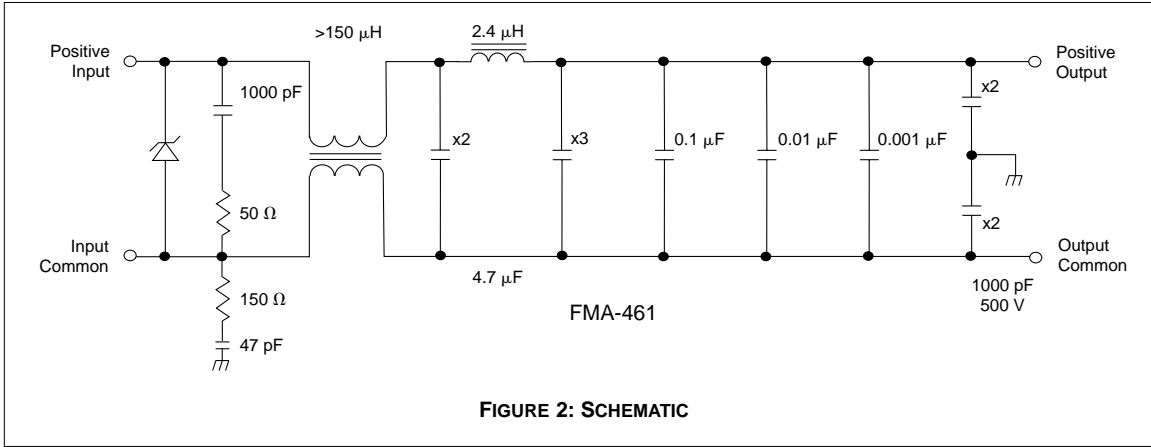

FIGURE 1: SCHEMATIC

EMI INPUT FILTERS

FM-461 EMI FILTER 1.75 TO 5 AMP



FM-461 EMI FILTER 1.75 YO 5 AMP

EMI INPUT FILTERS

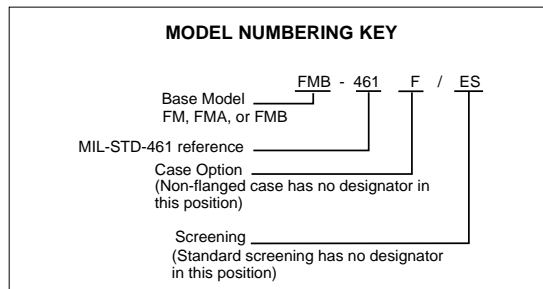
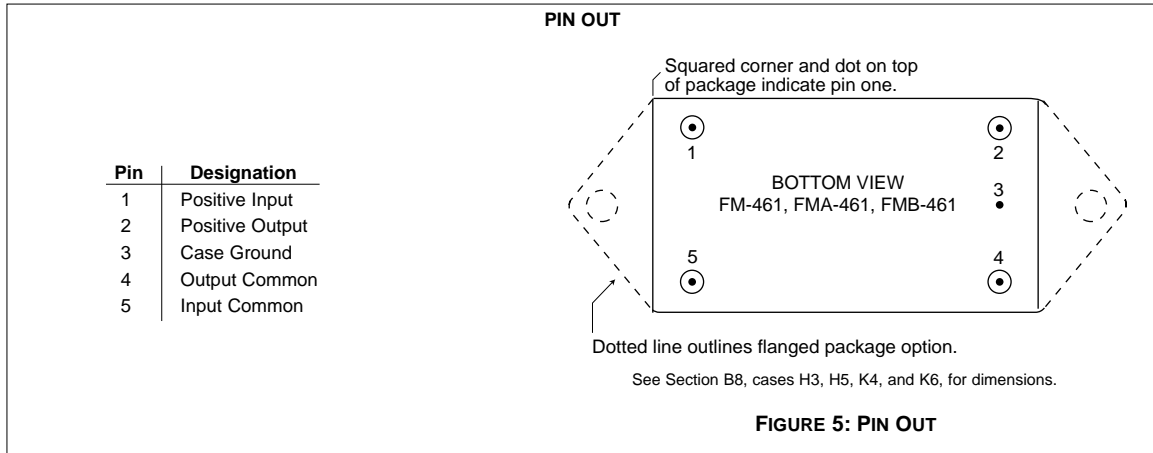

Typical Performance Curves: 25°C Tc , nominal Vin, unless otherwise specified.

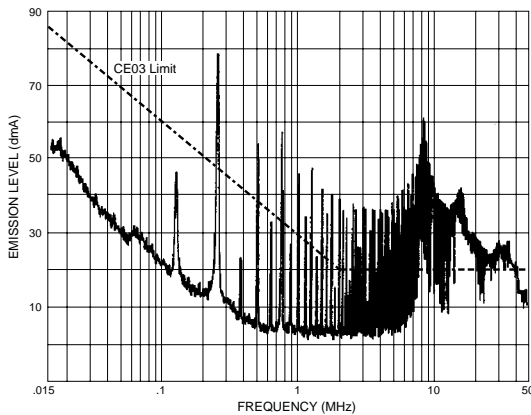

MHE Converter Without Filter

FIGURE 6

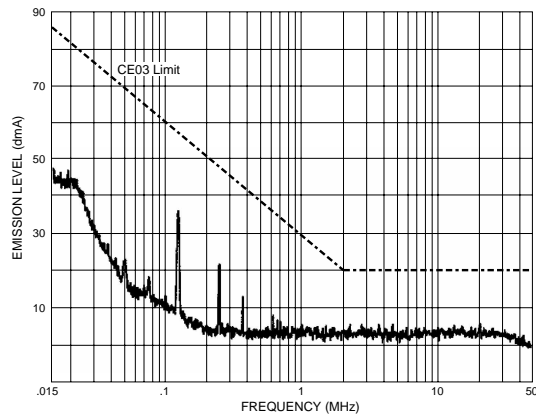

MHE Converter With FM-461 EMI Filter

FIGURE 7

26221-001-DTS Rev A DQ# 14006
All technical information is believed to be accurate, but no responsibility is assumed for errors or omissions. Interpoint reserves the right to make changes in products or specifications without notice. Copyright © 1990 - 1999 Interpoint. All rights reserved.

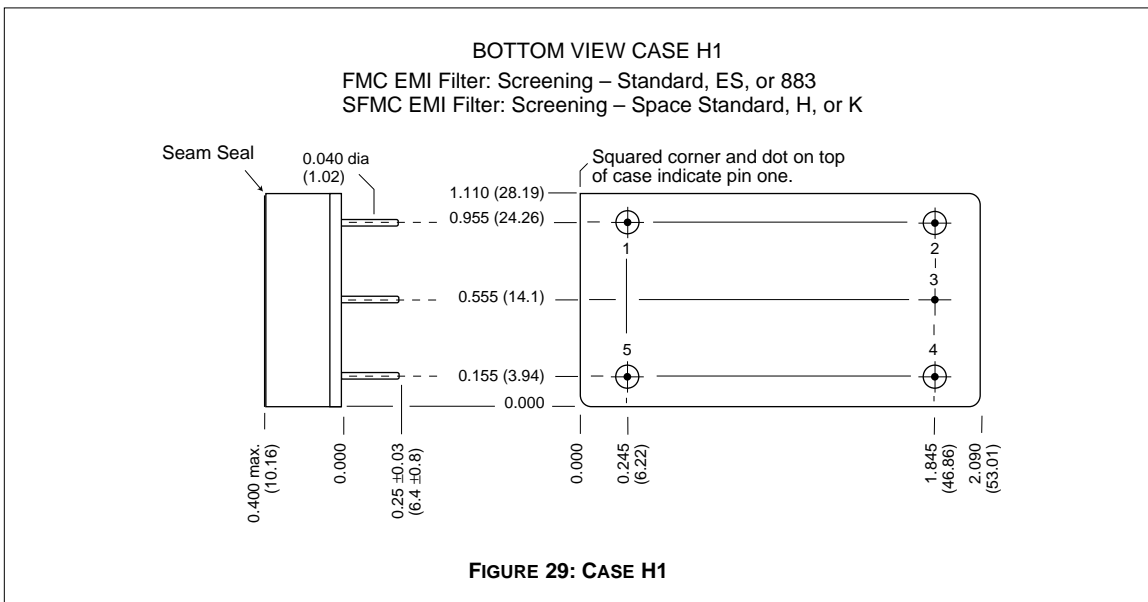
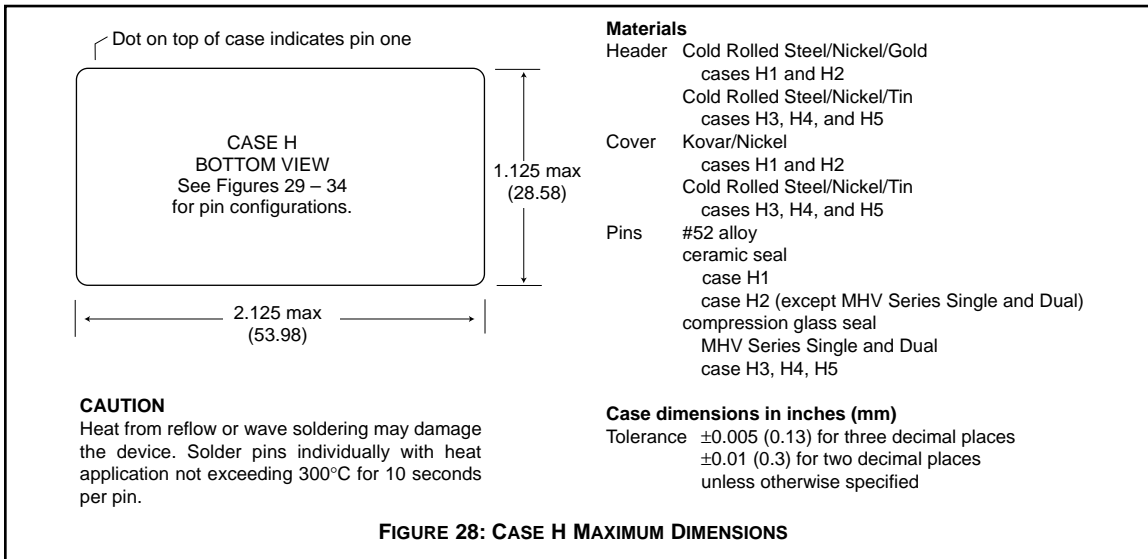

Note: Although every effort has been made to render the case drawings at actual size, variations in the printing process may cause some distortion. Please refer to the numerical dimensions for accuracy.

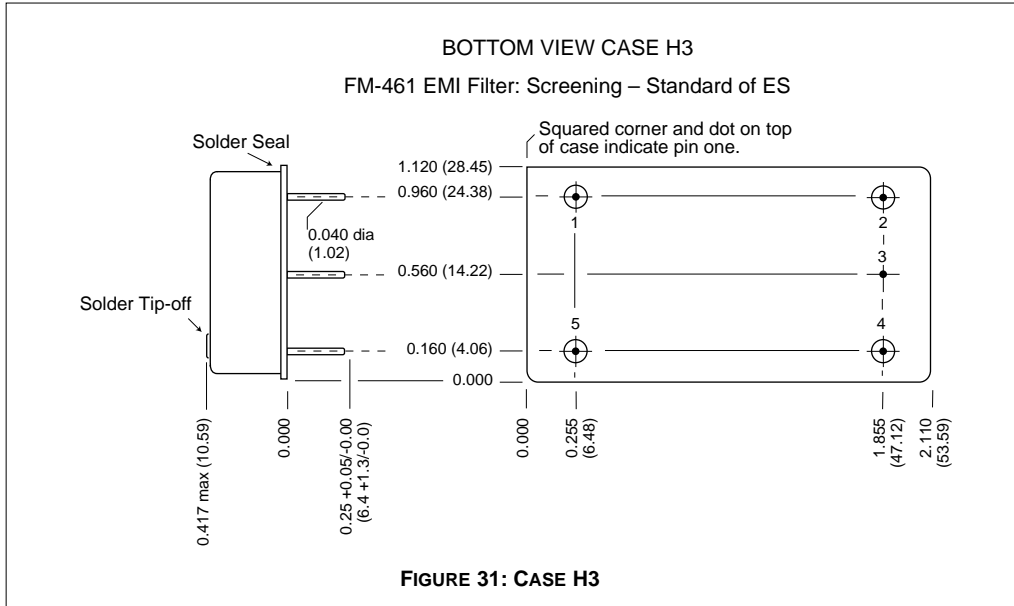

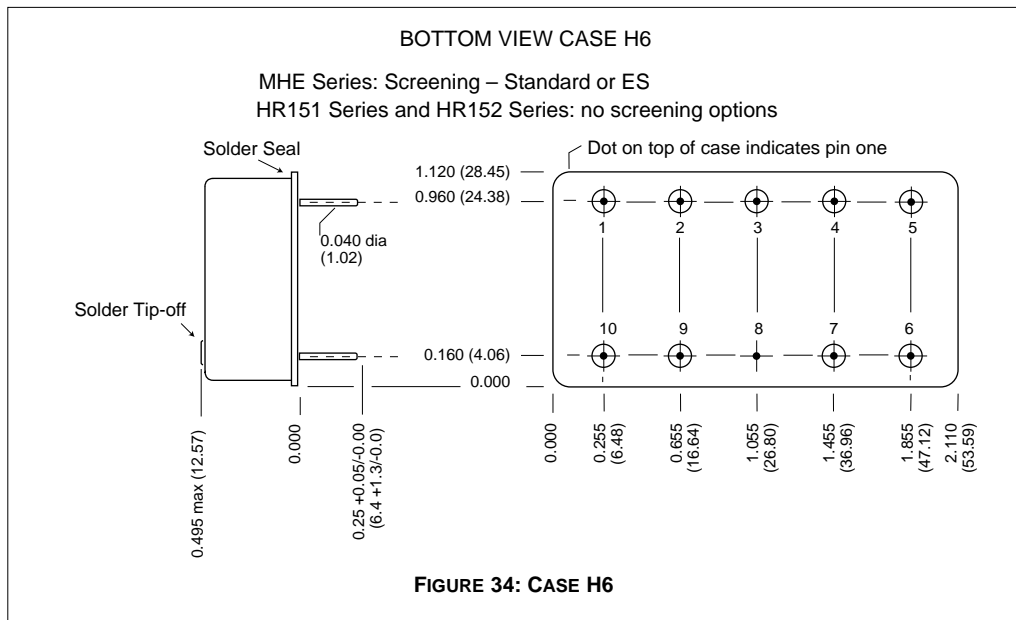
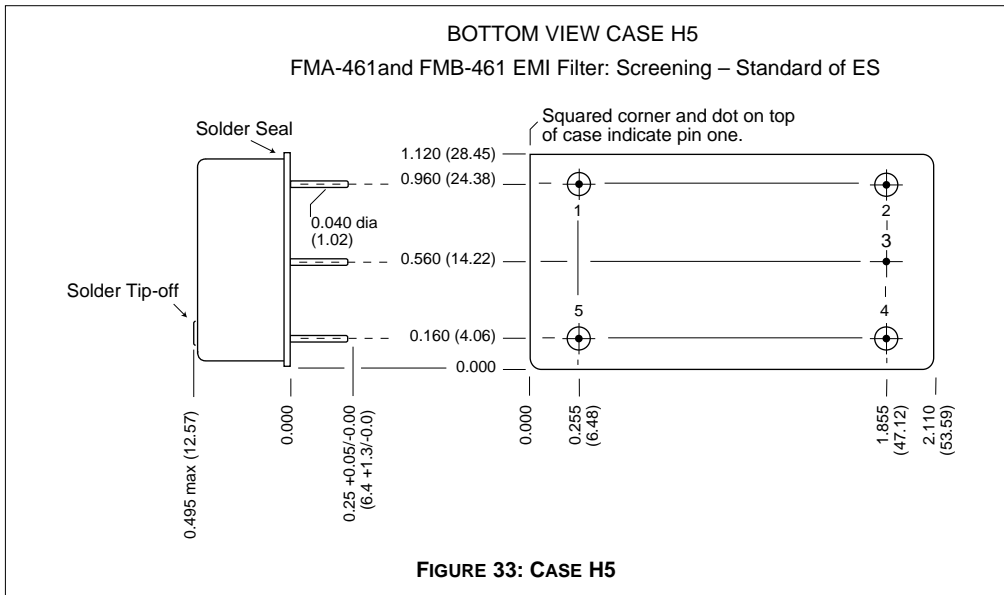

CASE K

CASES

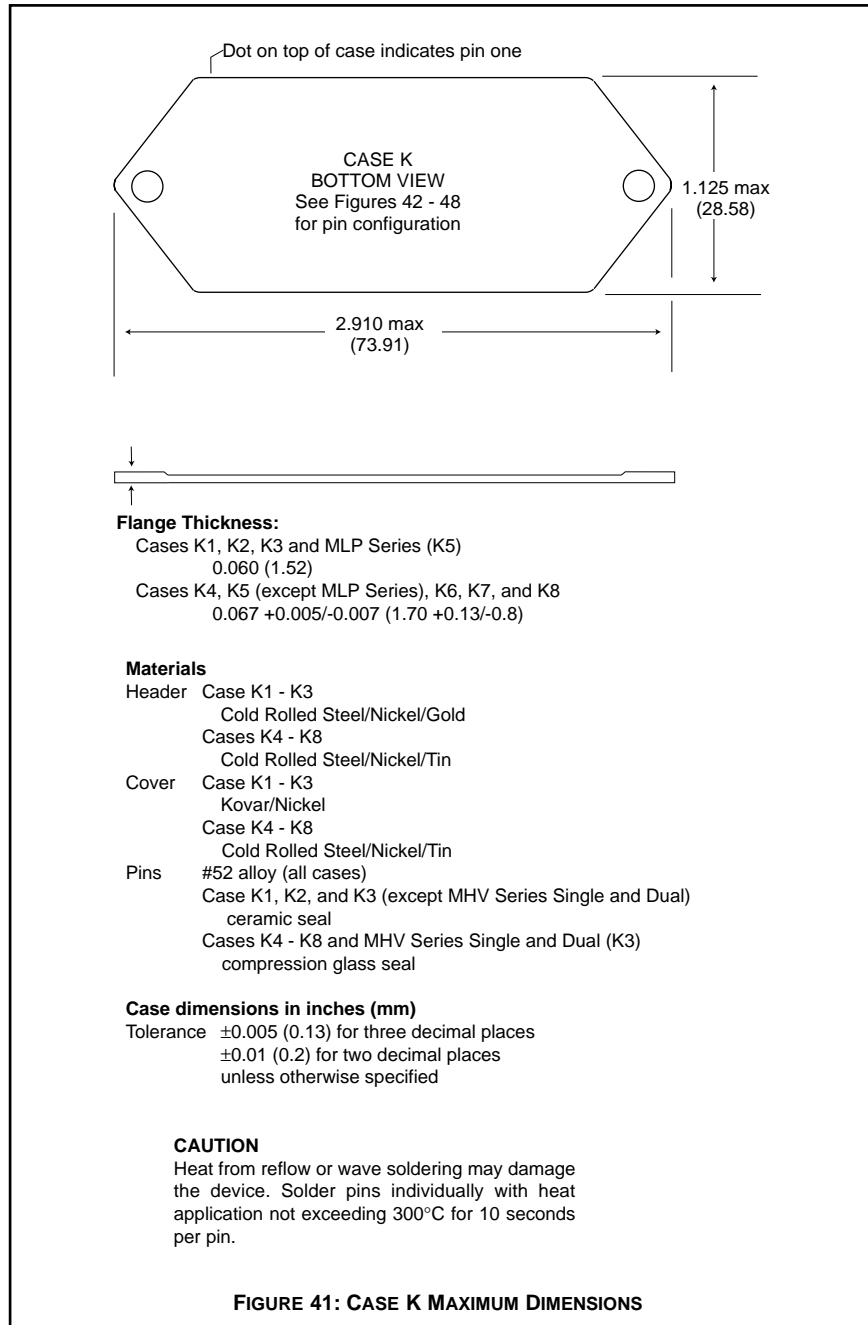

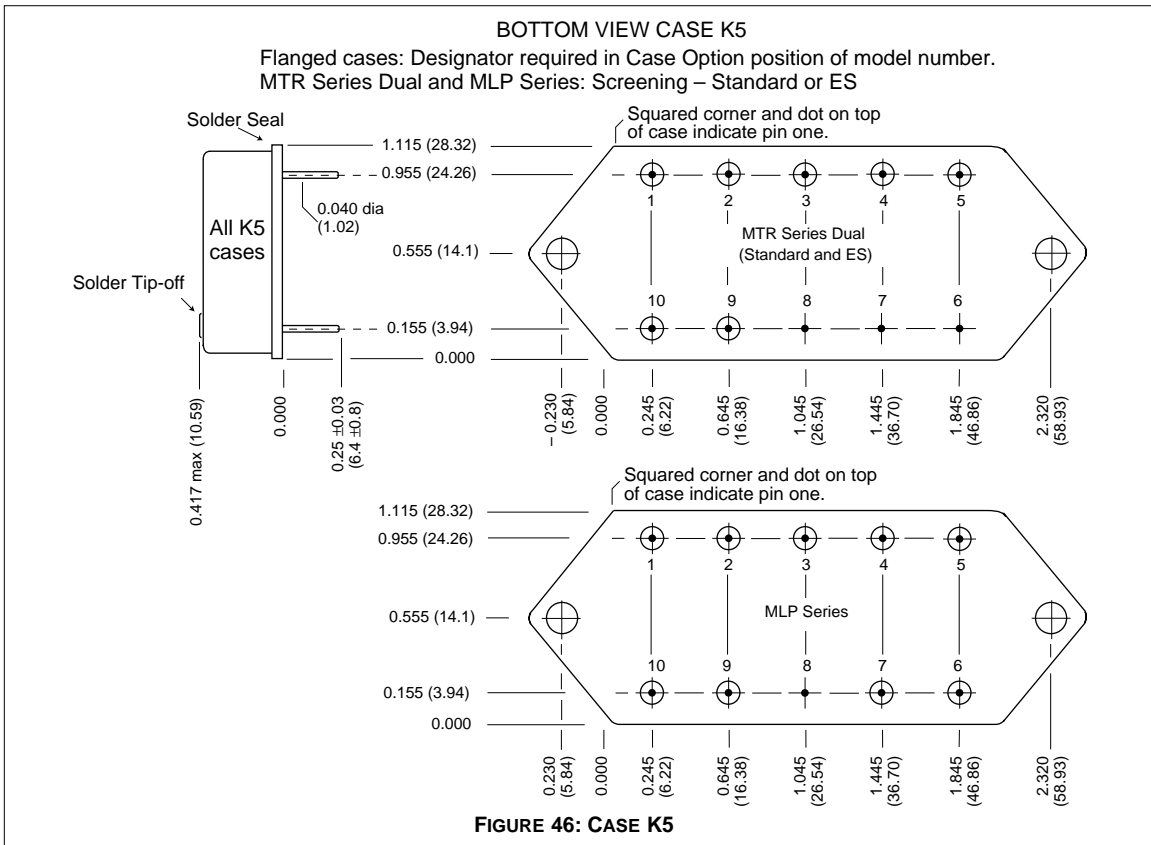
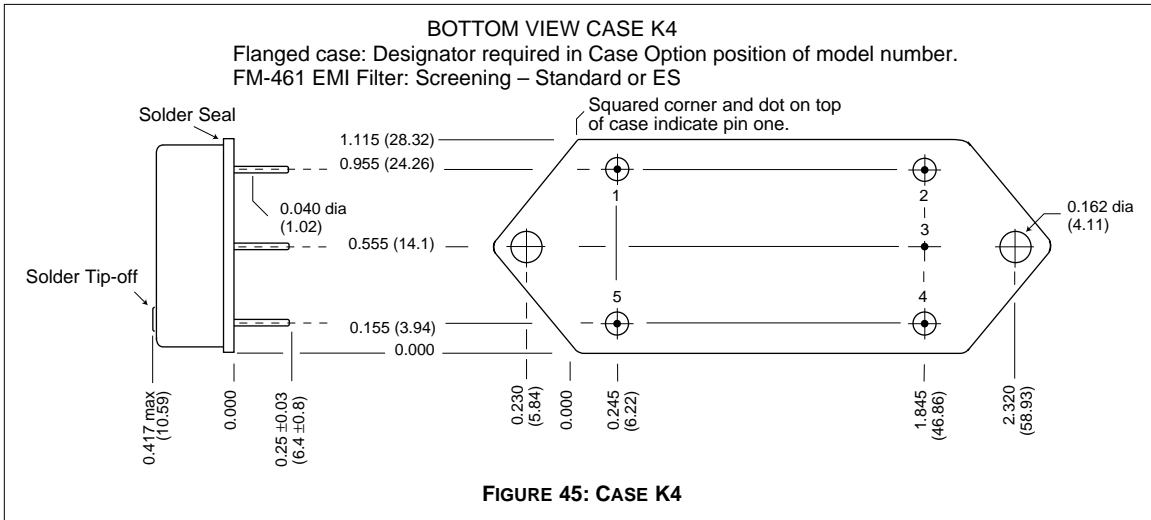

CASE K

CASES

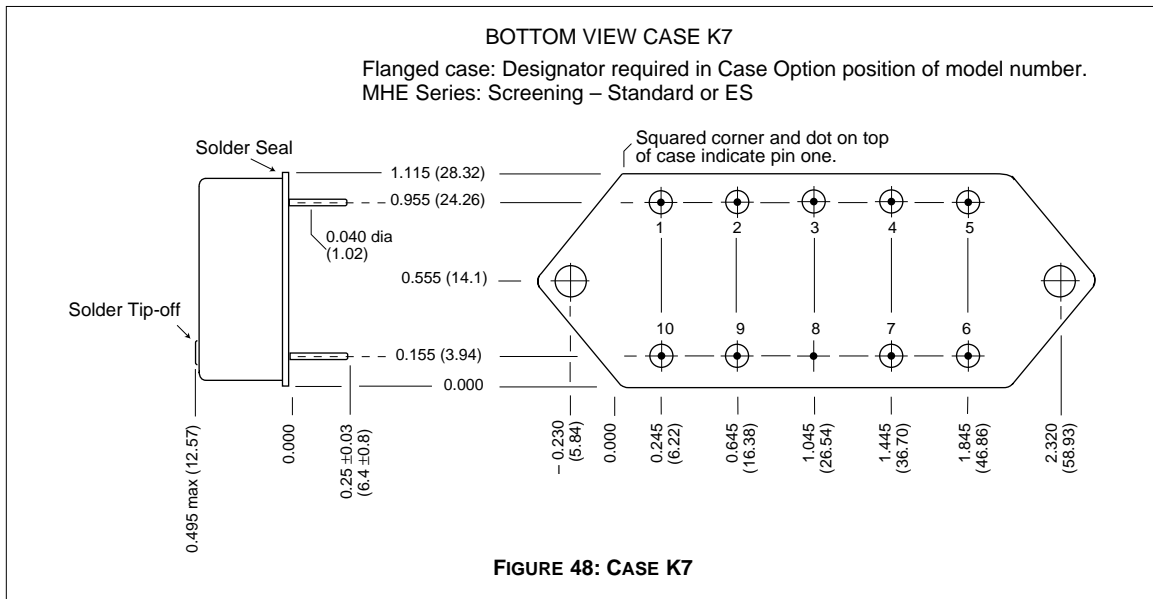
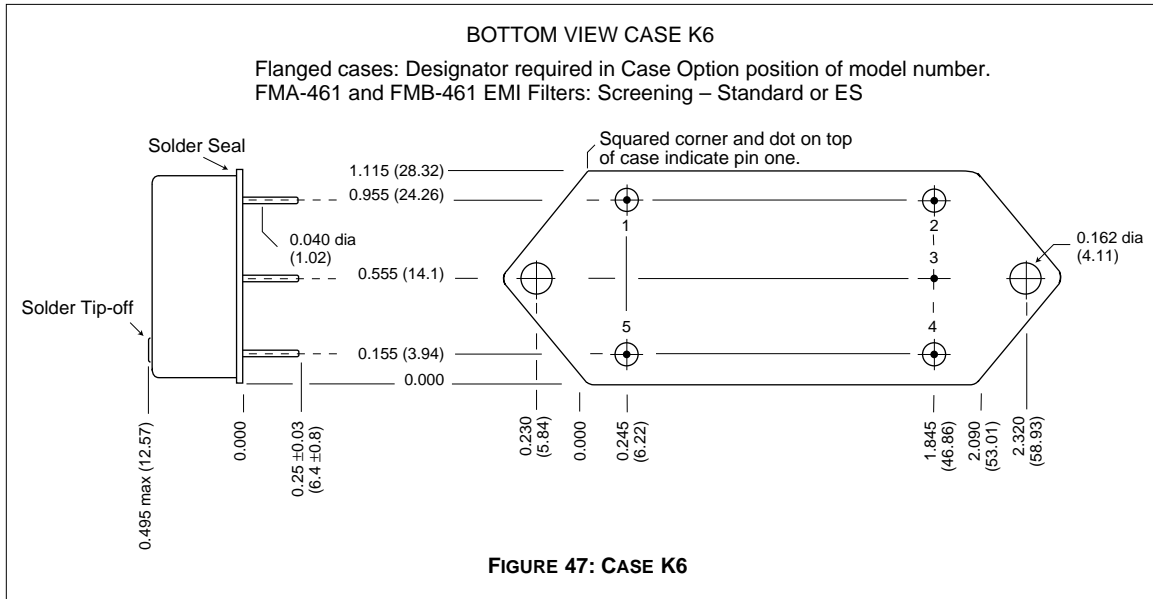

**QA SCREENING
85°C PRODUCTS**

85°C PRODUCTS

TEST (85°C Products excluding HR products)	STANDARD	/ES
PRE-CAP INSPECTION Method 2017	yes	yes
TEMPERATURE CYCLE (10 times) Method 1010, Cond. B, -55°C to 125°C	no	yes
CONSTANT ACCELERATION Method 2001, 500 g	no	yes
BURN-IN 96 hours at 70°C ambient (typical)	no	yes
FINAL ELECTRICAL TEST MIL-PRF-38534, Group A Subgroups 1 and 4: +25°C case	yes	yes
HERMETICITY TESTING Fine Leak, Method 1014, Cond. A Gross Leak, Method 1014, Cond. C Gross Leak, Dip (1 x 10 ⁻³)	no no yes	yes yes no
FINAL VISUAL INSPECTION Method 2009	yes	yes

Test methods are referenced to MIL-STD-883 as determined by MIL-PRF-38534.

Applies to the following products:

- MFW Series
- MTW Series
- MHE/MLP Series
- MHL Series
- MRH Series
- MTO Series
- MSR Series
- DCH Series
- FM/FMA/FMB EMI Filters
- MSF EMI Filter